

- KEY**
- brn brown
 - red red
 - org orange
 - ylw yellow
 - grn green
 - blu blue
 - vio violet
 - gray gray
 - wht white
 - blk black
 - prk pink
- COLOR**
- brn brown
 - red red
 - org orange
 - ylw yellow
 - grn green
 - blu blue
 - vio violet
 - gray gray
 - wht white
 - blk black
 - prk pink
- lower case 22 AWG
UPPER CASE 18 AWG

**WP1100X
PLAYER 2**

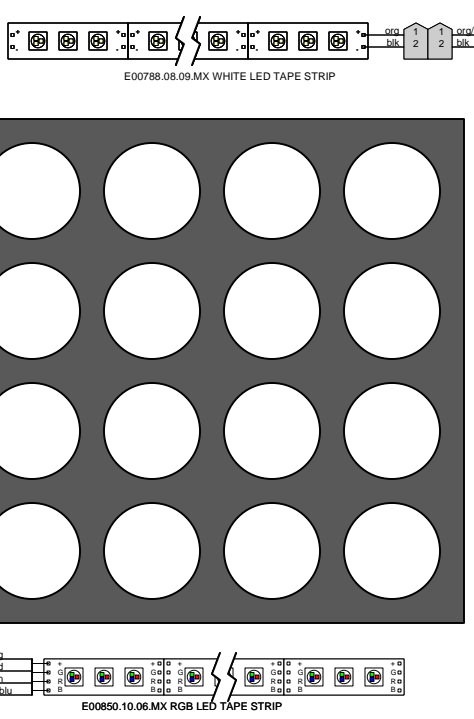

FOR 230V GAME
MAIN FUSE IS 4A SLO BLO

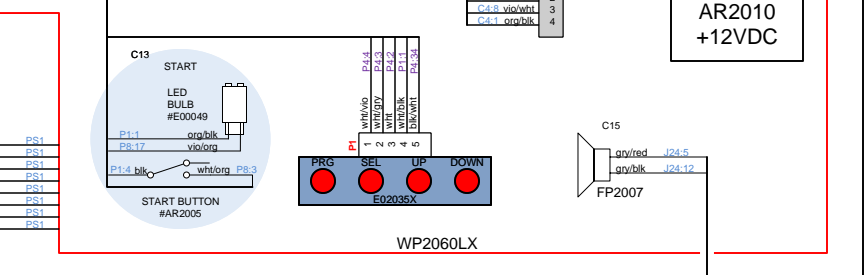
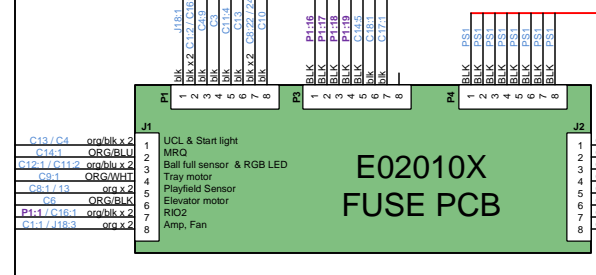
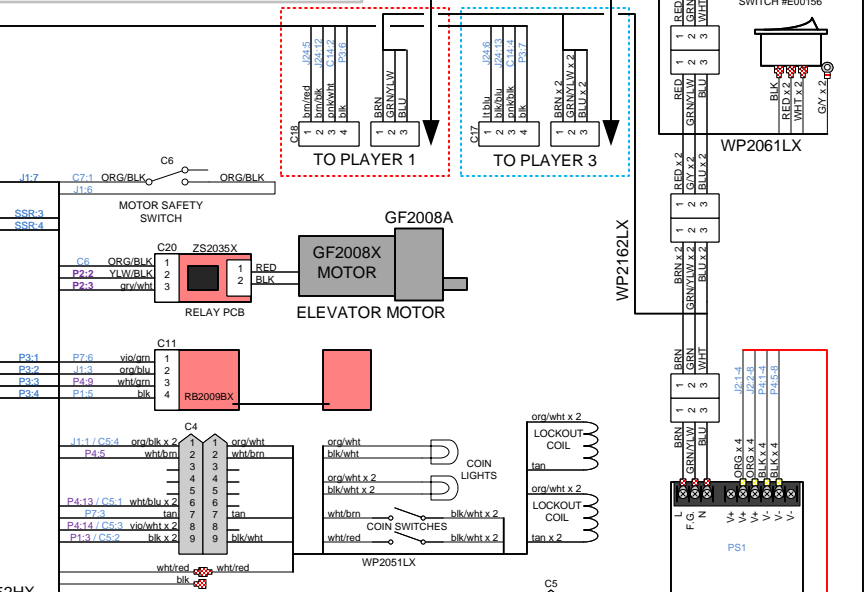
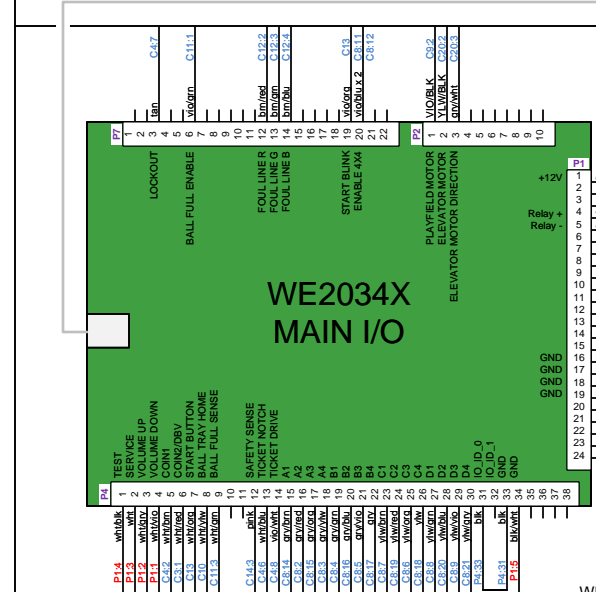
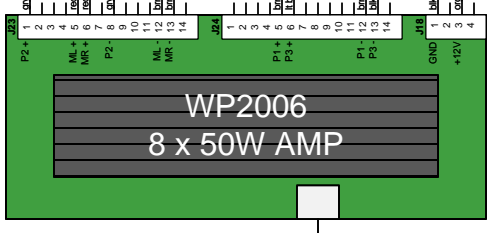
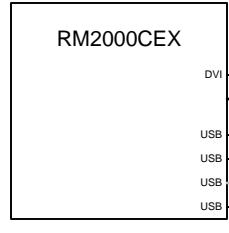
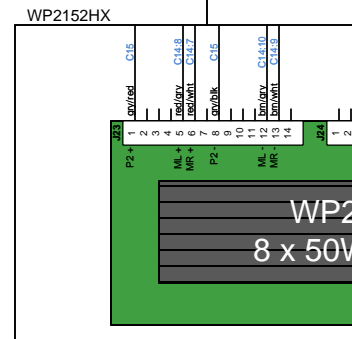
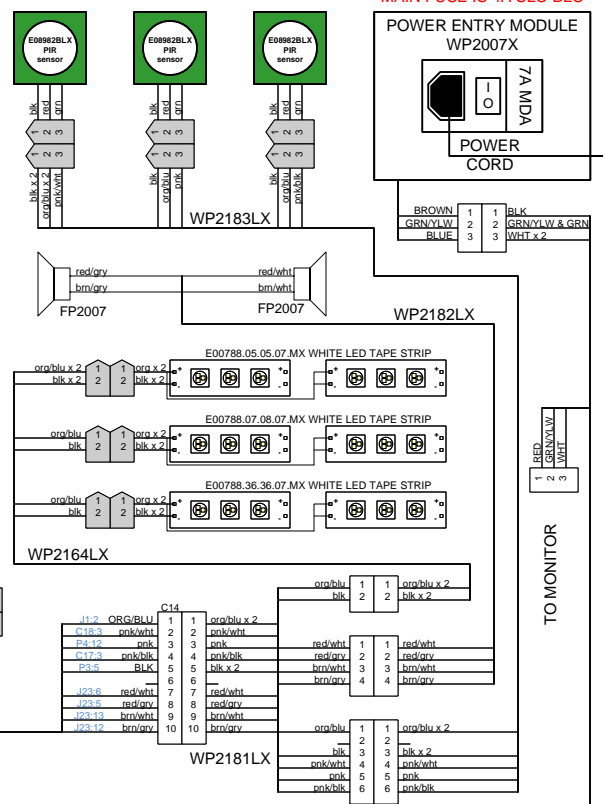
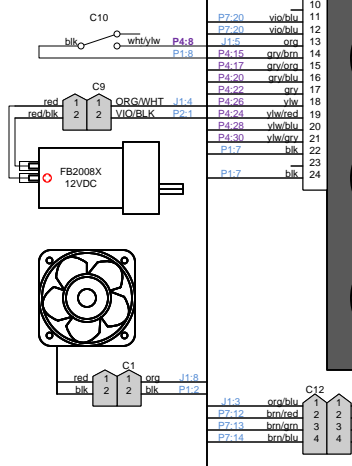
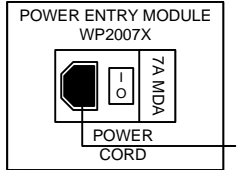

KEY	COLOR
brn	brown
red	red
org	orange
ylw	yellow
grn	green
blu	blue
vio	violet
gr	gray
wht	white
blk	black
prk	pink
lower case	22 AWG
UPPER CASE	18 AWG

WP1100X PLAYER 1 & 3

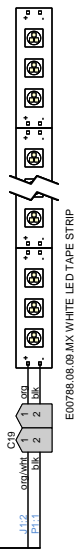
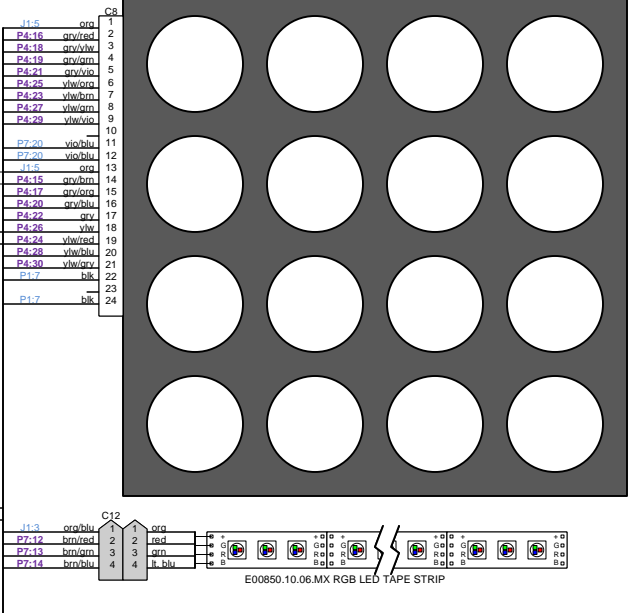
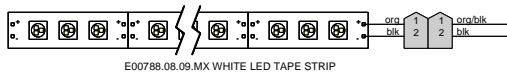

WP2151HX (player 1) WP2153HX (player 3)

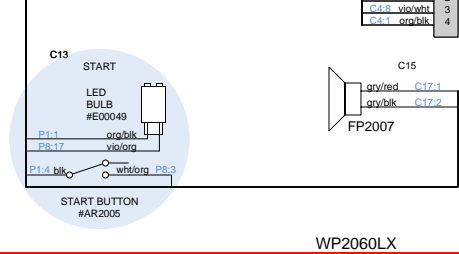
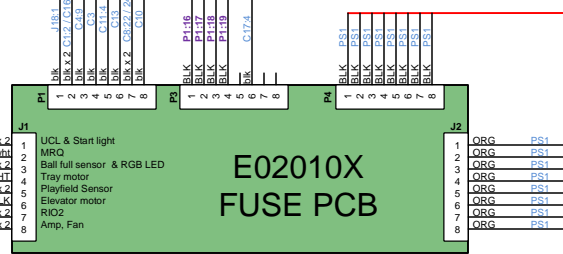
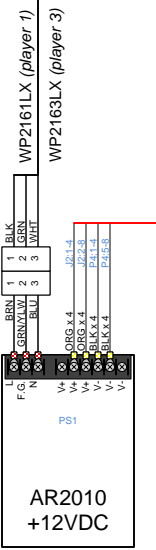
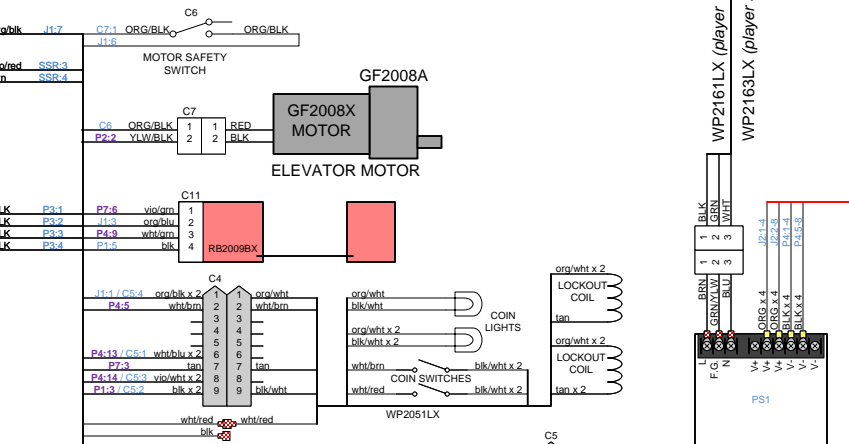
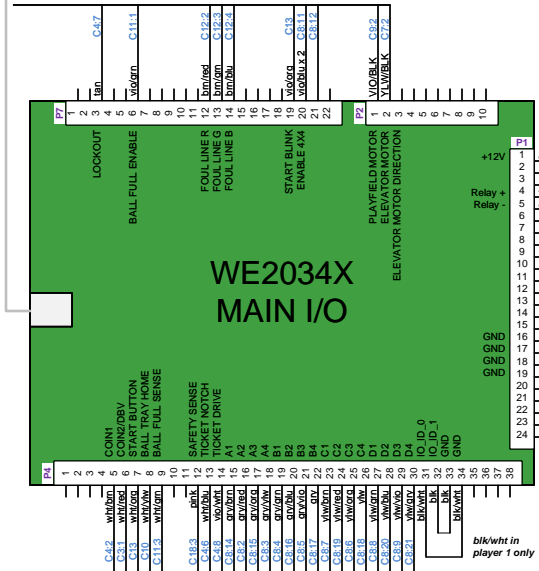
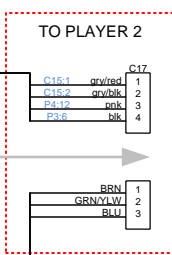

WP2060LX

E00784

AR2010
+12VDC