

revisions			
zone	ltr	description	date approved

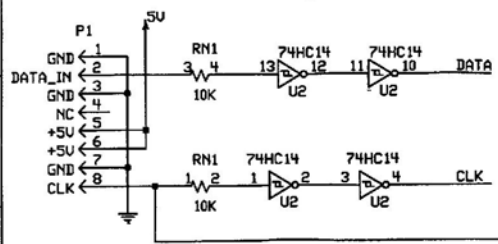
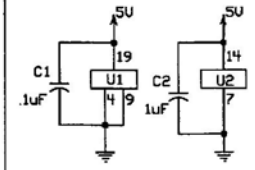
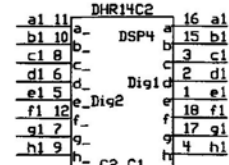
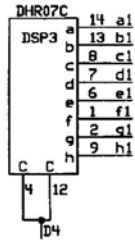
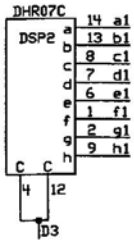
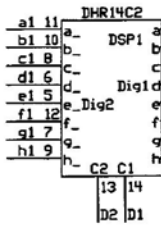
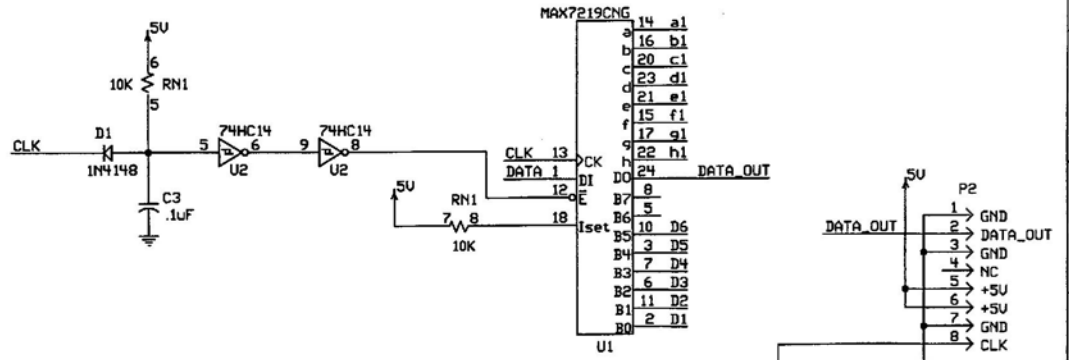

<b>I.C.E. Inc.</b>		
HOCKEY DISPLAY PC BOARD Schematic		
Prepared 3/93 SD	size code id drawing no.	
checked	no.	
engineer 4/93 GHD	C	
scale	sheet	