

# DUNK N' ALIEN!



## **OWNERS AND SERVICE MANUAL INNOVATIVE CONCEPTS IN ENTERTAINMENT INC.**

10123 MAIN STREET, CLARENCE, NY 14031

SERVICE: 1-716-759-0360

FAX: 1-716-759-0884

E-MAIL: [service@icegame.com](mailto:service@icegame.com)

WEBSITE: [www.icegame.com](http://www.icegame.com)

# TABLE OF CONTENTS

INTRODUCTION.....	PAGE 3
• GAME FEATURES	
• GAME PLAY	
ASSEMBLY.....	PAGE 4 - 5
• BEFORE YOU BEGIN	
• TOOLS NEEDED	
• INSTALLATION	
• SETTING A.C. LINE VOLTAGES	
• A.C. LINE VOLTAGE ADJUSTMENTS	
SET-UP / TESTING.....	PAGE 6 - 9
• SAFETY PRECAUTIONS	
• PROGRAMMING YOUR GAME	
• OPTION MODES	
• TESTING	
• DISPLAY CODES	
• ERROR CODES	
QUICK TROUBLESHOOTING.....	PAGE 10 - 11
• PROBLEMS AND SOLUTIONS	
REPAIR.....	PAGE 12 - 14
• OPERATIONAL BACKGROUND	
• MECHANICAL REPAIR	
• ELECTRICAL / ELECTRONIC REPAIR	
• MAINTENANCE	
PARTS LISTINGS.....	PAGE 15
SCHEMATICS / WIRING DIAGRAMS.....	PAGE 16 - 33
WARRANTY INFORMATION.....	PAGE 34 - 35

# INTRODUCTION

## GAME FEATURES

Thank you for your purchase of the new **DUNK 'N ALIEN™** Alley Roller game from I.C.E. This game is a whole new experience in the traditional Alley Roller genre. We have incorporated an interactive Alien that heckles the player while they are trying to hit a moving target. These new features make for a very memorable and exciting experience.

The game starts off with unparalleled ease of assembly. The game goes together in just a few minutes.

The game cabinetry is a unique plywood construction with a special overlay for a superior finish. A special lacquer finish is applied over the wood for a beautiful rich, deep look. All of the cabinet panels interlock together, are reinforced with cleats and are glued together to produce a cabinet that can handle all of the abuse you can give it.

Loading tickets is a snap, with our easy pull out drawer. This new feature drastically reduces the time needed to load tickets, as well as making it much easier to service ticket jams or the dispenser.

Long life fluorescent lighting is used throughout the game to lower maintenance and create a bright playfield area.

Reliability is the name of the game with our new ball release assembly. With a specially engineered solenoid and double linkages, this mechanism has been tested to last for years. Best of all, the entire assembly simply lifts out of the cabinet with no tools needed!

The best state of the art sound on sound audio is used to create an exciting atmosphere for the game player.

Another important feature of our game is the operator selectable "Balls per game". This feature allows the operator to control how many balls the game will normally deliver. This amount is adjustable from 3 to 9 balls per game. It is however important to note that **THE BALLS PER GAME IS NOT RELATED TO HOW MANY BALLS ARE IN THE GAME**. The game will work with 1 to 15 balls in the game, yet deliver the proper amount programmed into the game every time. (It is a good idea however to have at least 3 balls in the game to avoid slow play)

All programming is accomplished from the Main P.C. Board which is conveniently located at the front end of the cabinet. This make servicing and adjusting as easy as turning a key.

## GAME PLAY

Game play begins when a player has inserted enough money into the game to create 1 "Credit". At this point, the balls are released from the game and the games begins.

The player rolls the balls up the alley at the moving target and is awarded points from the possible target hit as well as the corresponding pocket the ball lands in.

The player continues to roll balls until they are all used up.

At the end of the game, the game will dispense tickets based on score. (If the game is so equipped)

# ASSEMBLY

## BEFORE YOU BEGIN

WARNING: WHEN INSTALLING THIS GAME, A 3 PRONG GROUNDED A.C. RECEPTACLE MUST BE USED. FAILURE TO DO SO COULD RESULT IN SERIOUS INJURY TO YOURSELF OR OTHERS. FAILURE TO USE A GROUNDED RECEPTACLE COULD ALSO CAUSE IMPROPER GAME OPERATION, OR DAMAGE TO THE ELECTRONICS

DO NOT DEFEAT OR REMOVE THE GROUNDING PRONG ON THE POWER CORD FOR THE SAME REASONS AS GIVEN ABOVE. USING AN IMPROPERLY GROUNDED GAME COULD VOID YOUR WARRANTY.

HAVE A QUALIFIED ELECTRICIAN CHECK YOUR A.C. RECEPTACLE TO BE SURE THE GROUND IS FUNCTIONING PROPERLY.

## TOOLS NEEDED

- Large Allen Key (Supplied)
- Phillips head screwdriver
- Security Allen Key
- Allen Key (1/8")

## INSTALLATION

1. Remove the banding from the pallet.

**NOTE: BE SURE TO STAND TO THE SIDE WHEN CUTTING THE BANDS, AS THEY ARE UNDER PRESSURE, AND COULD SPRING OUT CAUSING INJURY.**

2. Lift out all cage parts as well as any other parts shipped along with the game.
3. Remove the 2 game halves from the pallet.
4. Set the rear of the game into the approximate location of where it will be located. If assembling more than 1 game, you must leave space to run the power cord.
5. Set the front cabinet into position in front of the rear cabinet.
6. Open the coin and ticket doors and slide the left side cover forward enough to connect the harnessing from the rear cabinet to the front cabinet.

8. Slide the front cabinet into position. Insert the large Allen key into the holes on the sides of the front cabinet and rotate the Allen key 180° to lock the cabinet halves together.
9. Slide the right hand cover from the game.
10. Remove the packing material from around the ball release assembly.

NOTE: KEEP THE PACKING MATERIAL FOR THE BALL RELEASE ASSEMBLY BEHIND THE GAME IN CASE YOU DECIDE TO MOVE YOUR GAME LATER.

11. Open the parts box containing the balls and install them into the ball return release. (There should be balls supplied with the game)
12. Slide the right hand cover back onto the game.
13. Open the electronics access door. (Door in between the ticket and coin drawers)
14. Connect the long Computer style power cord to the Power Module. The power module is located inside the Electronics access door, to the lower right. Connect the other end to a grounded A.C. outlet.\*

\* Be sure before plugging the game in that it is wired for the proper A.C. voltage. One way to check is by looking at the game's serial number tag. It will indicate the rated voltage on it. If you are still unsure about what the game's voltage is set for, please refer to the "Setting A.C. line voltages" section in this manual.

15. Unpack the side cages. Attach to game cabinet using 2 black 1/4" bolts at the top and 2 security Allen bolts at the sides.
16. Unpack front glass and mount to front edge of side cages using 6 1/4-20 thumbscrews.
17. Unpack top Marquee. Locate front face of Marquee 1" back from top front edge of game. Attach using 3 square drive screws.

# ASSEMBLY

## SETTING A.C. LINE VOLTAGES

The game comes with 4 available line voltage settings as described below. These settings should be used to provide A.C. power in the correct range to the game without over or under powering it.

POWER RANGE	VOLTAGE SETTING
90-110 V.A.C.	110
110-130 V.A.C.	120
200-220 V.A.C.	220
220-240 V.A.C.	240

The game uses a POWER MODULE to handle all of the A.C. power distribution chores of the game. It incorporates an On-Off switch, primary A.C. game fusing, and power switching capabilities. This allows the game to be used with a wide variety of A.C. voltages by re-strapping the main transformer.

## A.C. LINE VOLTAGE ADJUSTMENT

To adjust the game for a different A.C. voltage:

- Unplug the game from the outlet.
- Disconnect the power cord from the power module.
- Using a small flat blade screwdriver, pry the fuse holder from the power module.
- Notice a small window on the fuse holder with an arrow that points to the voltage the game is presently set at.
- Using a small flat blade screwdriver, lift the retaining tab that holds the voltage selector in the fuse holder.
- Rotate the voltage selector until the voltage you want is displayed in the voltage select window.
- Push the voltage selector back into the fuse holder until it snaps into place. NOTE: Do not force the selector into the fuse holder. If it does not go in easily, it is not being installed correctly.

- Snap the fuse holder assembly back into the power module.
- Plug the power cord back into the receptacle in the power module, and into the wall outlet.

NOTE: WHEN CHANGING VOLTAGES FROM THE 110-120 TO 220-240 RANGE, LOWER THE MAIN FUSE AMPERAGE VALUE BY ½.

WHEN CHANGING FROM THE 220-240 TO 110-120 VOLT RANGE, DOUBLE THE MAIN FUSE AMPERAGE VALUE.

# SET-UP / GAME TESTING

## SAFETY PRECAUTIONS

**IMPORTANT: FAILURE TO FOLLOW THESE DIRECTIONS COULD CAUSE SERIOUS DAMAGE TO YOU OR YOUR GAME.**

**WARNING: WHEN INSTALLING THIS GAME, A 3 PRONG GROUNDED A.C. RECEPTACLE MUST BE USED. FAILURE TO DO SO COULD RESULT IN INJURY TO YOURSELF OR OTHERS. FAILURE TO USE A GROUNDED RECEPTACLE COULD ALSO CAUSE IMPROPER GAME OPERATION, OR DAMAGE TO THE ELECTRONICS**

**DO NOT DEFEAT OR REMOVE THE GROUNDING PRONG ON THE POWER CORD FOR THE SAME REASON AS GIVEN ABOVE. USING AN IMPROPERLY GROUNDED GAME COULD VOID YOUR WARRANTY.**

**HAVE A QUALIFIED ELECTRICIAN CHECK YOUR A.C. RECEPTACLE TO BE SURE THE GROUND IS FUNCTIONING PROPERLY.**

**REPLACE ALL INCANDESCENT BULBS WITH PROPER ICE SUPPLIED BULBS ONLY**

## PROGRAMMING YOUR GAME

This section will give you a detailed explanation of the functions and operating characteristics of each of the programming buttons.

PLEASE READ THIS SECTION CAREFULLY TO AVOID PROBLEMS WITH YOUR GAME.

**PLEASE NOTE: THE PROGRAMMING AND TEST BUTTONS ARE LOCATED ALONG THE FRONT EDGE OF THE MAIN P.C. BOARD THAT IS LOCATED BEHIND THE ELECTRONICS ACCESS DOOR. THIS DOOR IS BETWEEN THE TICKET AND COIN DRAWERS AT THE FRONT OF THE GAME.**

## PROGRAMMING BUTTON (PROGRAM / SW1)

Press this button to enter or exit the PROGRAMMING mode. Press this button once to enter programming mode. When in this mode, the game displays will display information pertinent to game programming. Press the button once again to exit programming mode.

Once in this mode you can press SW2, SW3 or SW4 to make adjustments to the game.

## SELECT BUTTON (SELECT / SW2)

This button is used to advance through all of the various programming option modes. Each push of this button will move you to the next programmable option. The option number is displayed in the "Balls Left" display.

## STEP UP BUTTON (UP / SW3)

This button is used to change the VALUE of a particular option mode. The operation mode values are displayed on the "SCORE" display. Each push of the button changes to the next HIGHER available value for that mode.

## STEP DOWN BUTTON (DOWN / SW4)

This button is used to change the VALUE of a particular option mode. Each push of the button changes to the next LOWER available value for that mode.

# SET-UP / GAME TESTING

## OPTION MODES

Please read the setting information carefully BEFORE making any adjustments. Failure to set options properly can yield unexpected results.

PLEASE NOTE: THE VALUES PRE-SET AT THE FACTORY HAVE BEEN FOUND TO WORK BEST AT MOST LOCATIONS.

### MODE 04 (COINS PER CREDIT) COIN INPUT #1

This mode determines how many coins are needed to create 1 credit for coin input #1. (This is also the only coin input normally adjusted for most usage) This value can be adjusted from 1-9. Setting a "1" would indicate 1 coin is needed to obtain 1 credit. A "2" would indicate 2 coins are needed to obtain 1 credit. The factory default for this setting is "2"

### MODE 01 (REAR CABINET SPEAKER VOLUME) ALIEN VOLUME

This mode is used to change the relative volume of the alien and rear cabinet sounds. "1" is the lowest volume setting and 9 is the highest. Each time the button is pushed, a sound is played to make it easier to determine where the volume should be set. The factory default for this option mode is "5". Setting this mode to "0" turns the rear cabinet sounds off.

### MODE 05 (BONUS CREDITS)

This mode is used to create "Bonus Credits". The way this option works is as follows: if a "3" is set, for every 3 coins put in AT THE SAME TIME, 1 extra credit would be given. The range for this option is 0-8. Setting a "0" turns this option off. The default value for this option is "0".

### MODE 02 (FRONT CABINET SPEAKER VOLUME) FRONT VOLUME

This mode is used to change the relative volume of the front cabinet sounds. "1" is the lowest volume setting and 10 is the highest. Each time the button is pushed, a sound is played to make it easier to determine where the volume should be set. The factory default for this option mode is "5". Setting this mode to "0" turns the rear cabinet sounds off.

### MODE 06 (ATTRACT MODE)

This mode will play the games "ATTRACT" mode when selected. The attract mode consists of the sound and motion being activated for a short time. The value for this mode (in minutes) is 1-30. The default value for this mode is 3.

### MODE 03 (COINS PER CREDIT) COIN INPUT #2

This coin input functions in an identical fashion to that of MODE 04. This option is generally used in markets that require the use of electronic multi-mechs. Consult our service department if you have any questions regarding the use of electronic multi-mechs.

### MODE 07 (ATTRACT MODE TYPE)

This mode has two choices. Setting this mode to 1 plays the attract mode without sound. Setting this mode to 2 plays the attract mode with sound and motion. The default setting for this mode is "2".

# SET-UP / GAME TESTING

## MODE 08 (BALLS PER GAME)

This mode determines the STANDARD amount of balls dispensed per game. This amount DOES NOT include any other balls that may be dispensed by other option settings.

NOTE: THE NUMBER SELECTED WILL DETERMINE HOW MANY BALLS ARE DISPENSED PER GAME. THE BALLS KEPT IN THE GAME DO NOT DETERMINE THE NUMBER. THE NUMBER OF BALLS IN THE GAME IS USED AS A BALL SUPPLY. THIS AMOUNT SHOULD NOT BE ALLOWED TO GO BELOW THREE (3) OR ABOVE FIFTEEN (15).

The range for this mode is 3-9. The default value for this option is "5".

## MODE 09 (POINTS PER TICKET)

This mode adjusts the points required to dispense one (1) ticket. Setting a value of 30 will dispense one (1) ticket for every 3,000 points scored. The range for this mode is 0-200. The default value for this mode is "30". (ticket for every 3,000 points scored)

## MODE 10 (MINIMUM TICKETS)

This mode sets the minimum number of tickets that can be dispensed by the game. This would be the equivalent of a "just for playing" option. The amount set IS NOT in addition to other tickets won. If the amount of tickets won exceeds the minimum amount set, that amount of tickets is awarded. The range for this mode 0-10. Setting a "0" turns this mode OFF. The default value for this mode is "4".

## MODE 11 (MAXIMUM TICKETS)

This mode sets the maximum number of tickets that can be dispensed by the game REGARDLESS of points scored. The range for this mode 0-50. Setting a "0" turns this mode OFF. The default value for this mode is "0".

## MODE 12 (DUNK BONUS)

This mode sets the number of tickets dispensed AFTER HITTING THE TARGET THREE (3) TIMES IN A ROW. The range for this mode is 0-100. The default setting for this mode is "10".

## MODE 13 (AUTO BALL ADVANCE)

This mode is needed for two reasons. First, if someone starts a game but does not complete it or walks away, there has to be a way to end the game. Second, if a ball is thrown into another game by mistake, the game would never end unless the game had a way to count down the number of balls played.

This mode eliminates both of the above problems by automatically counting down by one (1) ball every "XXX" number of seconds. ("XXX" represents the value set for this mode) The value set will be the number of seconds counted down between each ball. The range for this mode is 0-45. Setting a "0" turns this mode OFF. The default setting is "30".

## MODE 14 (AUTO BALL DISPENSE)

This mode works with MODE 13. After the time has run out for MODE 13, the game dispenses one (1) ball. This mode removes the problem of "too few balls in the game". The game is set to "0" or "1". Setting the game to "0" turns the mode OFF. The default setting for this mode is "0".



# SET-UP / GAME TESTING

## MODE 15 (TARGET ARM SPEED)

When this mode is selected, the speed of the target arm can be changed. The range for this mode is 5-25. The default for this mode is "15".

## MODE 16 (FACTORY DEFAULTS)

When this mode is selected, the game will reset to all the factory defaults for all modes.

SET "1", THEN EXIT PROGRAMMING MODE TO RESET ALL VALUES TO FACTORY DEFAULTS. The default for this mode is "0".

## GAME TESTING

After you have completed the set-up of your game, INSTALL TICKETS into the game, and play a few games to make sure everything is working properly. Check the following:

- Check the ticket dispenser to be sure the proper amount of tickets is given.
- Check that the game dispenses the correct number of balls.
- Check that the ALIEN JAW is moving.
- Check that the TARGET is moving and is lighting up.
- Check the game for proper scoring.
- Check that the "DUNK" sign (strobe light) lights up when the TARGET is hit.
- Check that the ALIEN drops and resets to the top when the TARGET is hit.

IF YOU HAVE ANY QUESTIONS REGARDING  
THE PROGRAMMING OPTIONS, PLEASE  
CALL OUR  
SERVICE DEPARTMENT AT:  
1-716-759-0360

## GAME TESTING

### DISPLAY CODES

Errors are detected upon power up. The game will go through a "power up" sequence:

Display 0  
Display 11111  
Display 22222  
Target Lights go out  
Display 33333  
Display 44444  
Target Lights return  
Display 55555  
Display 66666  
Display 77777  
Display 88888  
Display 99999  
Target Arm swings for 4 seconds  
Alien Motor Starts  
Alien Gets to top

### ERROR CODES

If no errors exist, then the game will start up automatically. If errors exist, a display with "Er" in the Ball Display will show which errors had occurred during self test.

1 = Left Ball Sensor  
2 = Ball Sensor to right of #1  
3 = Center Ball Sensor  
4 = Ball Sensor to right of #3  
5 = Right Ball Sensor  
6 = Ball Count Sensor  
7 = Alien at Top Sensor  
8 = Motor Position Sensor  
9 = Target Switch stuck on  
10 = Coin 1 Input Stuck on  
11 = Coin 2 Input Stuck on  
12 = EEPROM Error - New for New Jersey

The game will continue to display these errors until power is cycled. Since some of the errors involve moving motors, it is safer to have the operator look at and correct the errors without devices moving unexpectedly. Once the errors have been corrected, a power cycle will have the game test again and if all are well, the game will function normally.

# QUICK TROUBLESHOOTING

## **GAME WILL NOT TAKE OR ADD MONEY CORRECTLY**

- Micro switch not working or returning properly. Check and repair or replace as necessary.
- Game programming set-up incorrectly. Refer to service manual for proper settings.
- Bad harnessing or connector. Check w/ohm meter and repair if necessary.
- Bad Main P.C. Board. Check and repair or replace as necessary.

## **START BUTTON WILL NOT FLASH WHEN GAME HAS CREDITS, OR WORK WHEN PUSHED**

- Micro switch not working properly. Test and replace as necessary.
- Micro switch popped out of housing. Snap back into housing.
- Burned out light bulb. Replace light bulb.
- Bad harnessing or connector. Check w/ohm meter and repair as necessary.
- Bad Main P.C. Board. Check and repair or replace as necessary.

## **GAME HAS NO SOUND**

- Bad speaker. Check w/ohm meter for 8-ohm load and replace if defective.
- Volume level set incorrectly. Check service manual for volume setting procedures.
- Bad Harnessing or connector. Check w/ohm meter and repair if necessary.
- Bad Main P.C. Board. Check and repair or replace as necessary.
- Main P.C. Board fan bad & I.C.'s overheated. Replace fan.

## **BALLS WILL NOT RELEASE OR WILL NOT STOP RELEASING**

- Solenoid burned out. Replace solenoid.
- Solenoid sticks in. replace solenoid.
- Release lever binding. Check, lubricate or replace as necessary.
- Release return spring broken. Replace spring.
- Bad ball count sensor. Check and replace as necessary.
- Bad connector or harnessing. Check w/ohm meter and repair as necessary.
- Bad Opto-isolator. Check w/ohm meter and replace if necessary.
- Bad Main P.C. Board. Check and repair or replace as necessary.
- Debris jamming ball return system. Clean return area.

## **GAME WILL NOT ADD POINTS CORRECTLY / COUNTS BALLS WHEN NOT THROWN**

- Bad score sensor. Check and repair or replace.
- Score sensor wiring bad. Check w/ohm meter and repair or replace.
- Cabinet harnessing bad. Check w/ohm meter and repair or replace as necessary.
- Sensors loose or misaligned. Realign sensors.
- Main P.C. Board bad. Check and repair or replace as necessary.
- Check sensors on play cups (look for red LED on opto board)
- Beam is blocked
- Bent opto brackets

## **TICKET DISPENSER DOES NOT WORK OR WORKS IMPROPERLY**

- Bad harnessing. Check w/ohm meter and repair if necessary.
- Bad ticket dispenser. Repair or replace ticket dispenser.
- Dispenser out of tickets. Add tickets.
- Bad Main P.C. Board. Check and repair or replace as necessary.
- Optical sensor on dispenser dirty. Clean sensor.

## **SCORE DISPLAY WILL NOT LIGHT OR WORKS IMPROPERLY**

- No power on Main P.C. Board. Check transformer and fuses / check power module
- Bad connectors or harnessing. Check w/ohm meter and repair as necessary.
- Bad Display P.C. Board. Repair or replace as necessary.
- Bad Main P.C. Board. Repair or replace as necessary.

## **TARGET ARM DOES NOT PIVOT PROPERLY**

- Check linkage, set screws and mounting hardware. Repair/replace if broken or missing.
- Check motor

# QUICK TROUBLESHOOTING

## **ALIEN UP/DOWN MOTION**

- Check Magnet Switch. Replace if defective
- Sprocket loose on motor. Tighten set screws/replace sprocket.
- Opto Board not working. Replace.
- Lift Pin on Chain missing. Replace link & pin.
- Motor not working. Replace motor.

## **ALIEN - NO JAW MOVEMENT**

- Jaw binding. Check movement of solenoid rod.
- Check for loose harness connections.

## **ALIEN EYES**

- Eyes not lighting up. Check harness connections/replace eye boards.

## **NO FLUORESCENT LIGHTING**

- Bad connectors or harnessing. Check w/ohm meter and repair as necessary.
- Bad ballast transformer. Replace ballast transformer.
- Bad bulb. Replace bulb.
- No A.C. power to game. Check main fuses in power module.

REFER TO THE NEXT SECTION FOR DETAILED INFORMATION  
ON REPLACEMENT OF P.C. BOARDS AND MECHANICAL COMPONENTS

# GAME REPAIR

**WARNING: ALWAYS REMOVE POWER TO THE GAME BEFORE ATTEMPTING ANY SERVICE, UNLESS NEEDED FOR SPECIFIC TESTING. FAILURE TO OBSERVE THIS PRECAUTION COULD RESULT IN SERIOUS INJURY TO YOURSELF OR OTHERS.**

## OPERATIONAL BACKGROUND

The **DUNK 'N ALIEN™** game has been designed with MODULAR repair in mind. The coin drawer and ticket drawer can be slid out and removed in their entirety to be worked on in another area if desired. The ball release assembly can be removed as a unit with no tools necessary, making repair a snap.

The ball release system utilizes an A.C. Pull type solenoid that has been specifically designed to eliminate residual magnetism problems commonly found in this type of solenoid. The solenoid is powered via an Opto-isolator, to eliminate solenoid noise from the electronic circuitry.

Other than the display, all electronics and power supply components are located on the Main P.C. Board to make modular type replacement fast and simple. The display board has been designed to be very reliable and easy to repair. Very few drive components are necessary for this type of display.

## TROUBLESHOOTING PHILOSOPHY

To find problems with the game, always first check what should be obvious. See that the game is plugged in and that all of the fuses on the game are good. This includes the fuse that is located **INSIDE** the power module.

Next, check to see that all of the connectors are firmly seated and that none of the wires have pulled out of them.

When trying to find out if specific components are bad or not, try swapping them with components from another player station to see if the problem moves with the component, or stays where it was. This will help you to know if you have a problem with a specific component, or maybe a problem with either the wiring or the Main P.C. Board.

Use extreme caution when using probes or volt if the game is powered up. If doing continuity checks, it is important to disconnect the harnessing at both, as attached they may yield erroneous results.

If P.C. Boards are suspected as causing problems, check to see that all of the I.C. chips are firmly seated on the boards.

If light bulbs are suspected, swap them with one that is known to work to narrow the problem down to the bulb or P.C. Board.

## MECHANICAL REPAIR

### BALL RELEASE ASSEMBLY

**WARNING: BE SURE POWER HAS BEEN REMOVED FROM THE GAME BEFORE PROCEEDING.**

1. Open the cash box drawer at least 6 inches.
2. Pull forward on the ball release cover. (The panel with the clear plastic window) about 3 inches to disengage, then lift off.
3. Remove the balls from the game.
4. Grasp the release assembly by the rail and slowly lift out, being careful to avoid hitting the sensors on the cover retaining screws.
5. Disconnect the connector that connects the release assembly to the game.

### SOLENOID REPLACEMENT

1. Remove the spring from the solenoid and mounting bolt.
2. Remove the cotter pin from the clevis pin and slide the clevis pin from the solenoid shaft and linkage.
3. Carefully scribe a mark when removing the solenoid to be sure the replacement is properly located.
4. Remove the hardware that secures the solenoid to the mounting plate.

# GAME REPAIR

5. When re-assembling, be sure to use the same size cotter pin to retain the clevis pin, as this pin is needed to hold the spring to the solenoid assembly.
6. Be sure the bent over end of the cotter pin is trimmed so it cannot contact the solenoid body.

## SOLENOID REPLACEMENT

1. The ball count sensor must be replaced as an assembly. Remove the transmitter, receiver and sensor P.C. Board from the release assembly.
2. When replacing the unit, it is important to remember to use the star washers. This will prevent the sensors from rotating or loosening.
3. Be sure to install the new sensors in the same position as the old ones. This is important to insure proper alignment and consequently proper ball count

## BULB REPLACEMENT

1. The bulbs replace easily. Pull the bulb straight out of the socket.
2. Insert the new bulb into the socket and snap into place.

# ELECTRONIC REPAIR

## DISPLAY ASSEMBLY

### SCORE DISPLAY ASSEMBLY

1. Unlock and remove the display cover.
2. Remove the Phillips head screw at the top of the display mounting bracket.
3. Lift the entire assembly straight up, then pull the bottom forward and remove connectors from the rear.
4. Unscrew the display from the mounting bracket.
5. Assemble in reverse order.

## BULB REPLACEMENT

1. Unlock and remove the display cover.
2. Pull the old bulb straight out of the socket.
3. Push a new bulb straight into the socket and snap into place.

## MAIN P.C. BOARD

1. Turn off A.C. power and remove the power cord from the power module.
2. Remove all P.C. Board connectors noting where each one connects into the board.
3. Remove the 4 hex fasteners that retain the board to the mounting bracket.
4. Re-assemble in reverse order.

## BALL RETURN SENSOR

1. Turn off game power.
2. Open cash drawer at least 6 inches.
3. Slide ball release cover from right hand side of game.
4. Sensor assembly is located at the rear of the ball return channel where the 2 cabinets meet.
5. Unscrew the sensor assembly and remove.
6. Assemble in reverse order.

NOTE: BE SURE THE TRANSMITTER WIRING IS KEPT HIGH ENOUGH FOR THE BALLS TO PASS UNDER. IF THERE IS ANY SLACK, IT IS IMPORTANT TO REMOVE IT USING A TIE WRAP, ETC.

# GAME REPAIR

## SCORE SENSORS

1. Remove all A.C. power from the game.
2. Remove the 6 screws from the front of the cage and remove the front of the cage.
3. Remove the single screw from the bottom of each cage side and remove the sides.
4. Remove the 2 retaining screws on the playfield.
5. Remove the playfield.
6. Re-connect power to the game and put the game in test mode.
7. Run your hand through each sensor pair and listen for the sound to indicate proper function.
8. If the sensor does not indicate proper function, remove the sensor and replace.
9. Re-assemble in reverse order.
10. Re-test the assembly when finished.

## MAINTENANCE

Maintenance is easy as the game requires very little service under normal use. To get the best out of the game, please perform the following as indicated:

- Clean the playfield weekly using Wildcat pinball cleaner.
- Clean the playfield once every 3 months with a buffing wheel and Novus polish.
- Oil the levers and linkages on the release system every 6 months.
- Polish the cabinet with a good grade of spray furniture polish every 6 months.

# PARTS LISTINGS

## MECHANICAL PARTS

AR1001	Ball Rail
AR1002	Ball Return Tray
AR1003	Rail Support Spacer
AR1004	Ball Release Lever Spring
AR1005	Cash Box
AR1007	Solenoid Linkage
AR1009	Ball Release Lever Brkt.
AR1011NH-P402	Channel Cover, Left
AR1012NH-P402	Channel Cover, Right
AR1016	Alley Edge Protector, Rear
AR1018	Ball Release Lever
AR1019	Alley Edge Protector, Front
AR1020	Cup Connecting Plates
1024	Ticket Bin
1026	Ticket Bin Switch Mtg. Brkt.
AR1029	Speaker Grille
DA1060-P802	Cage, Left Side
DA1061-P802	Cage, Right Side
AR2017	Diffuser Support
DA3000	Runaway Material w/ Adhesive
DA3012	Ball Diverter Block
DA4013	Netting
AR3001	Ball Jump
AR3020	Runaway Ball Bumper Material
AR3021	Ball Stop Grommet
DA3024	Ball
DA3035	Front Glass
AR3065	Runaway Ball Bumper Cap, Left Side
AR3066	Runaway Ball Bumper Cap, Right Side
DA3017	Ball Diverter
5014	Coin Door Lock
5101	Mech Holder
6105	Latch Tool
6111	Fiber Lever Washer
6117	Clevis Pin 3/4"
6118	Clevis Pin 1"

## GRAPHICS & DECALS

DA7001	Decal - Large Logo
DA7002	Decal - Small Logo
DA7003	Decal - Coin Door Decal
DA7004	Decal - Ticket Door
DA7006	Decal - Back - Inside
DA7008	Instruction Panel
DA7009	Fuse Rating Decal
DA7011	Decal - Bonus Points
DA7014	Decal - Hit The Target
DA7015	Decal - Playfield Score
DA7022	Marquee Upper - Dunk
DA7024	Decal - Tank Left
DA7025	Decal - Tank Right
DA7026	Decal - Tank Middle
DA7027	Marquee
DA7030	Decal - Bubbles
DA7031	Decal - Alien Eyes
DA7032	Decal - ICE Logo
DA9001	Service Manual

## ELECTRICAL / ELECTRONIC PARTS

211	Low Ticket Switch
248	PL7 Transformer
249	PL7 Bulb
251	PL7 Socket
FP2000X	Display P.C. Board
DA2002	Transformer
AR2005	Start Button
AR2007	Speaker 6 X 9
AR2008	Solenoid
RB2009X	Optical Sensor Assembly
CC2027	20 Ft. Computer Style Power Cord
AR2028X	Ball Eject P.C. Board (AR Model)
DA2034X	Main P.C. Board Assembly
HH2050	Power Module
2111	Solid State Relay
HH5005	Ticket Dispenser (Entropy)
PC20224	Counter, 12 Volt D.C.
PC20429	Red Diffused L.E.D.
DA2001X	Power Supply
SR2008AX	Motor Assembly - (Wiring only) - Alien
DA2008	Motor - Target

PLEASE CALL OUR SERVICE  
DEPARTMENT FOR HELP WITH ANY  
PARTS NOT SHOWN ON THIS LIST

PHONE 1-716-759-0360

4 3 2 1

**DA2057AX  
COIN DOOR INTERFACE**

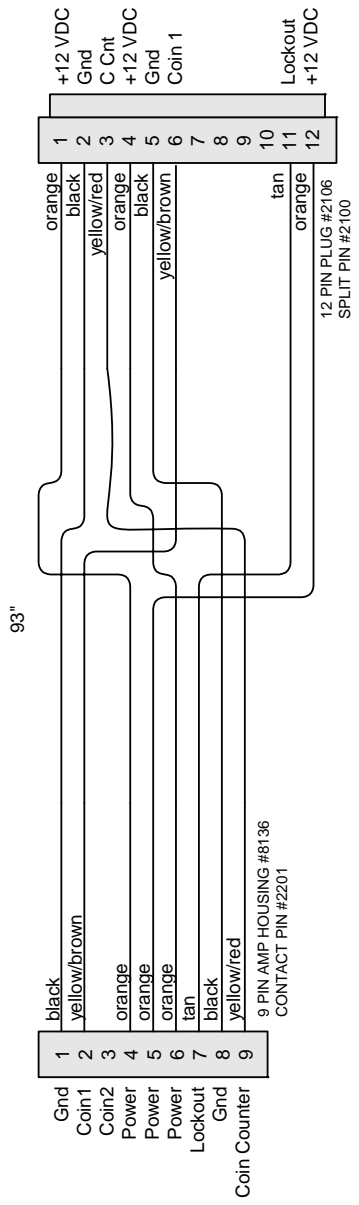

**DA2058AX  
TICKET DOOR INTERFACE**

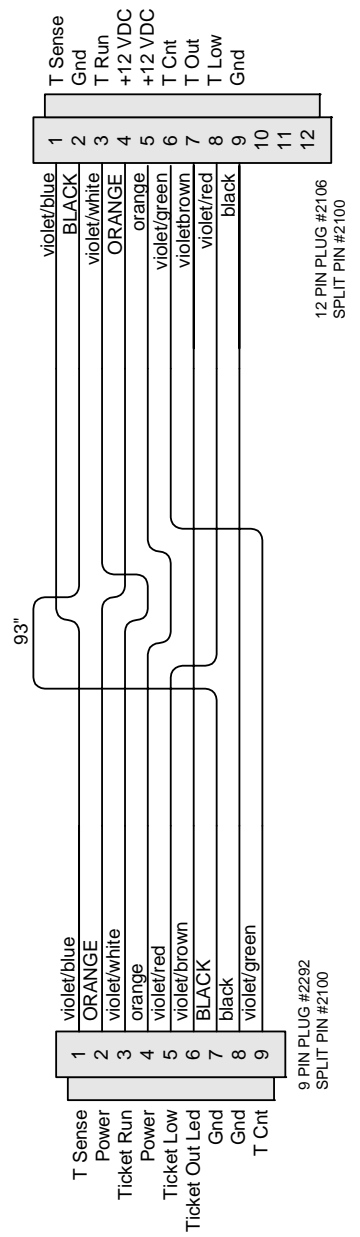

A

TITLE		DA1000X	
DESCRIPTION		DA2057AX-COIN DOOR INTERFACE	DA1000XREV2.VS
DATE		6/26/03	D
REVISED		3/26/04	DRAWN BY
PAGE		1	MVANHORN
1 OF 22			

4 3 2 1



1 2 3 4

D C B A

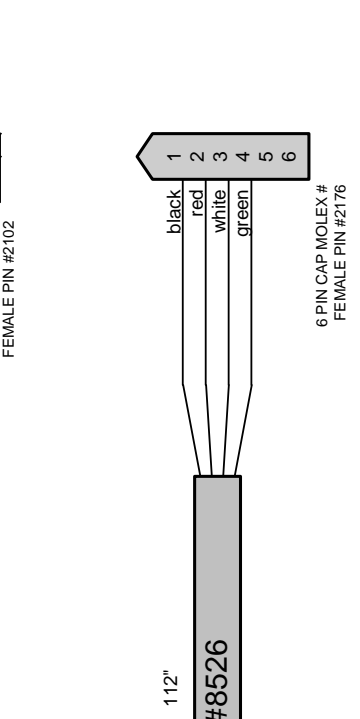
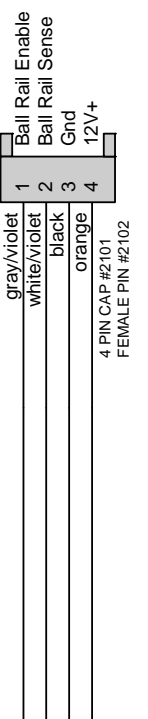
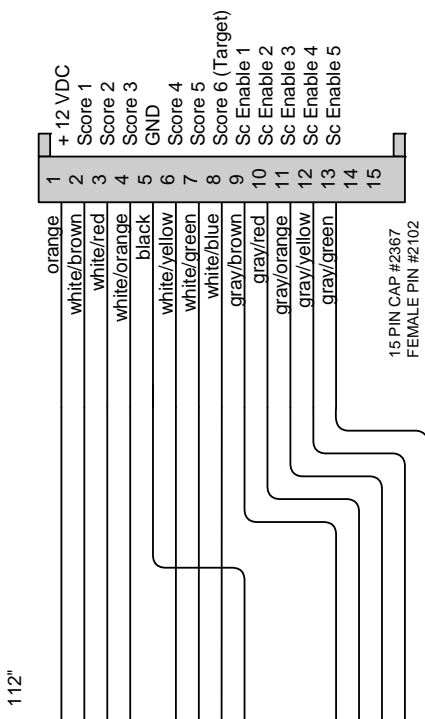

TITLE		DA1000X	
DESCRIPTION	DA2055AX - SCORE SENSOR INTERFACE	FILENAME	DA1000XREV2.VS
DATE	6/26/03	DRAWN BY	MVANHORN
REVISED	3/26/04	PAGE	2 OF 22

1 2 3 4

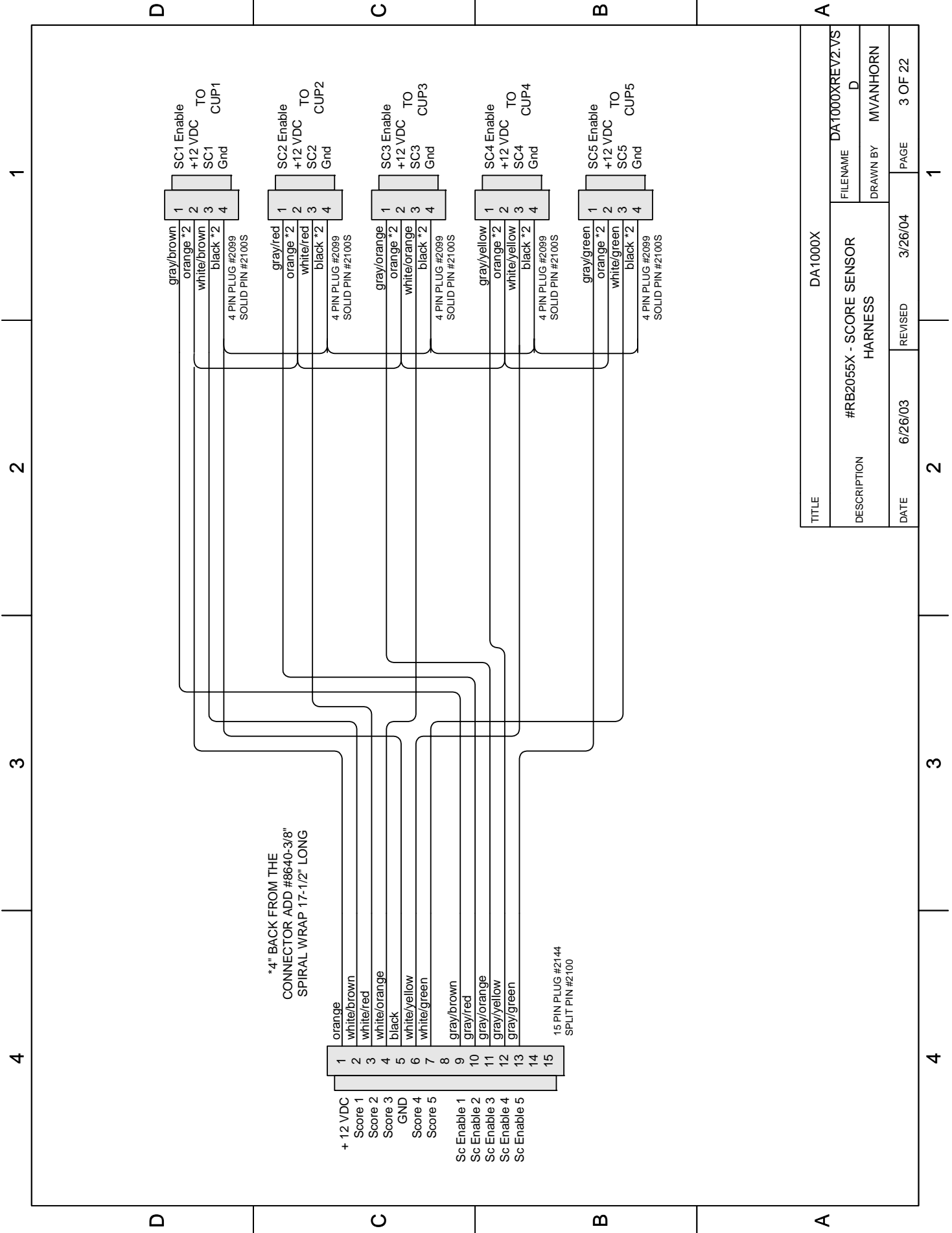

TITLE		DA1000X	
DESCRIPTION		#RB2055X - SCORE SENSOR HARNESS	FILENAME D
DATE		6/26/03	DRAWN BY MVANHORN
REVISED		3/26/04	PAGE 3 OF 22

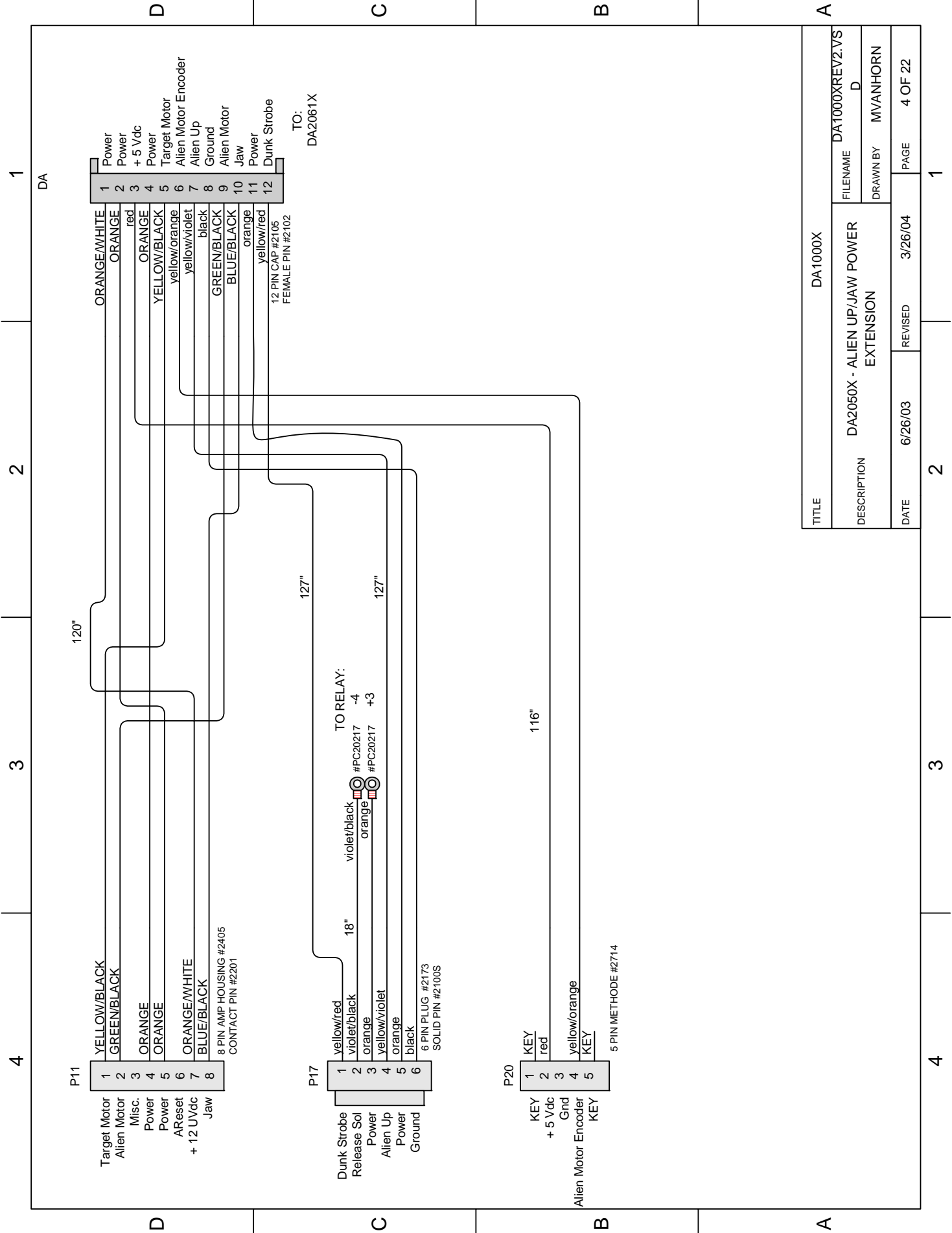

1	ORANGE/WHITE
2	ORANGE
3	red
4	ORANGE
5	YELLOW/BLACK
6	yellow/orange
7	yellow/violet
8	black
9	GREEN/BLACK
10	BLUE/BLACK
11	orange
12	yellow/red

12 PIN CAP #2105  
FEMALE PIN #2102

TO:  
DA2061X

TITLE	DA1000X		
DESCRIPTION	DA2050X - ALIEN UP/JAW POWER EXTENSION	FILENAME	DA1000XREV2.VS
DATE	6/26/03	DRAWN BY	MVANHORN
REVISED	3/26/04	PAGE	4 OF 22



1 2 3 4

D

C

B

A

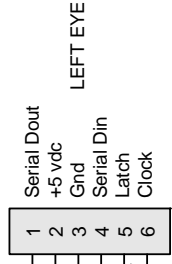

6 PIN METHODE  
#8634

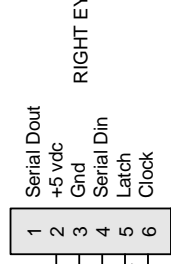

6 PIN METHODE  
#8634

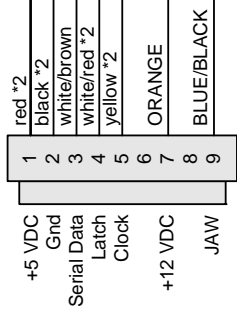

9 PIN PLUG #2292  
SPLIT PIN #2100



2 PIN CAP #2181  
FEMALE PIN  
#2102

34"

16"

34"

20"

TITLE	DA1000X		
DESCRIPTION	DA2052X - EYE/JAW HARNESS	FILENAME	DA1000XREV2.VS
DATE	6/26/03	DRAWN BY	MVANHORN
REVISED	3/26/04	PAGE	6 OF 22

1 2 3 4

D

C

B

A

4 3 2 1

D C B A

DA2053X - EYE/JAW EXTENSION

DA2072X - EYE/JAW INTERFACE

REG. 18 AWG WIRE

18 AWG FLEX WIRE slight twist  
DO NOT CAP UNTIL RAN THROUGH EYE/JAW HARNESS TO: DA2052X

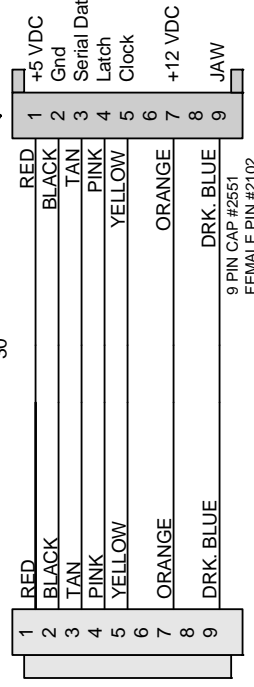
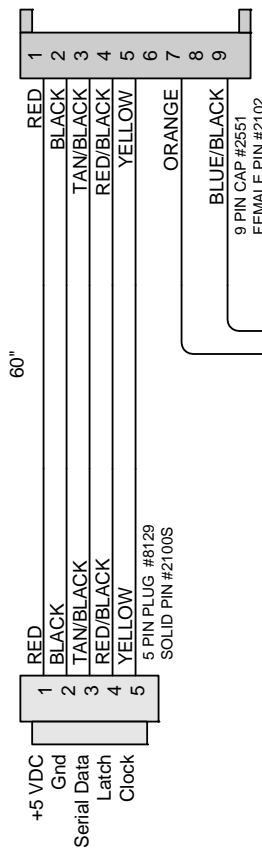

TITLE		FILENAME	DA1000XREV2.VS
DESCRIPTION		DRAWN BY	IMVANHORN
DA2053X - EYE AND JAW EXTENSION	DA2072X - EYE AND JAW INTREFACE	REVISIED	3/26/04
DATE	6/26/03	PAGE	7 OF 22

4 3 2 1



1 2 3 4

D D

C C

B B

A A

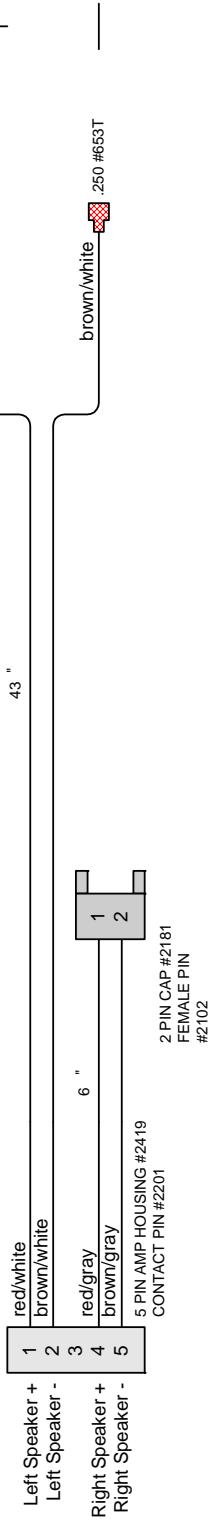

TITLE	DA1000X		
DESCRIPTION	DA2051X speaker harness	FILENAME	DA1000XREV2.VS
DATE	6/26/03	DRAWN BY	D MVANHORN
REVISED	3/26/04	PAGE	9 OF 22

1 2 3 4



1 2 3 4

D C B A

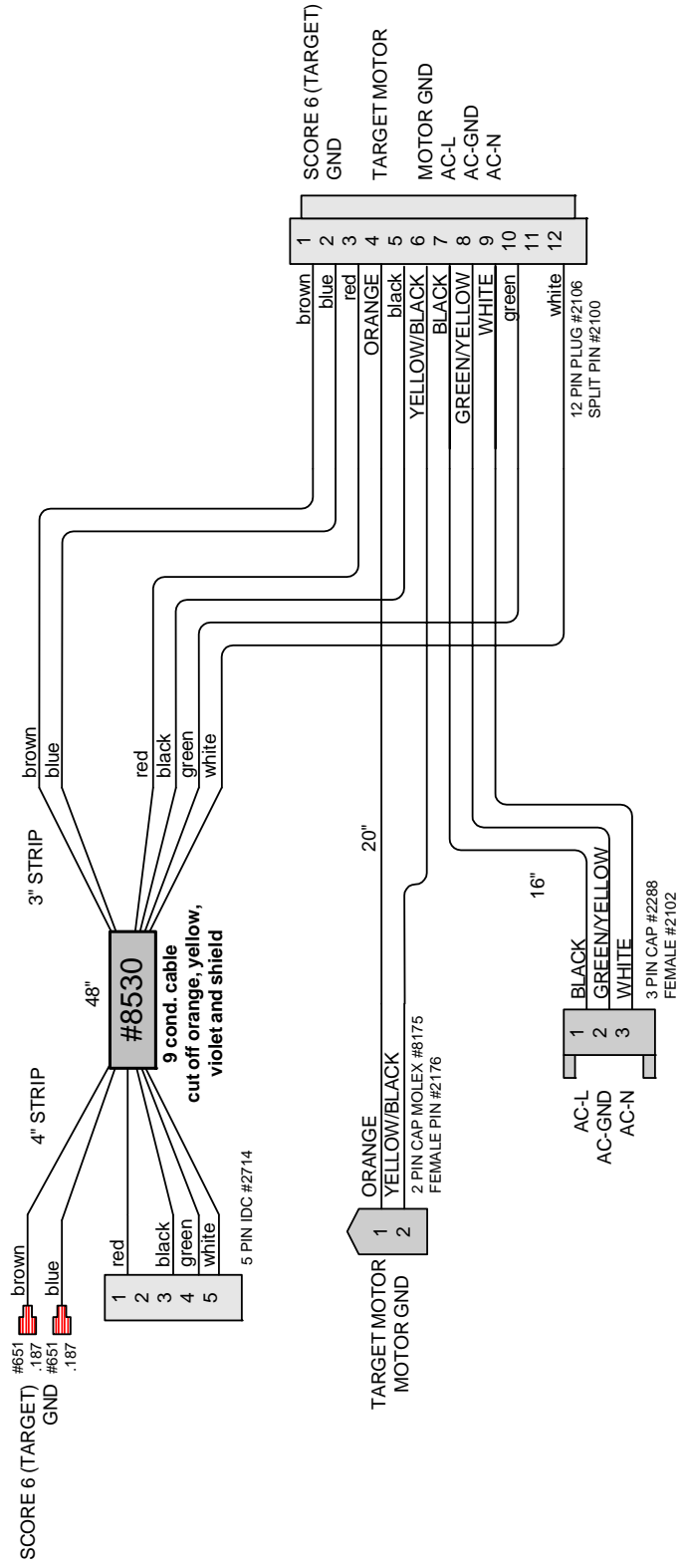

TITLE		DA1000X	
DESCRIPTION		DA2062X - PLAYFIELD	
DATE	6/26/03	REVISED	3/26/04
FILENAME	DA1000XREV2.VS	DRAWN BY	MVANHORN
PAGE	10 OF 22	PAGE	1

1 2 3 4

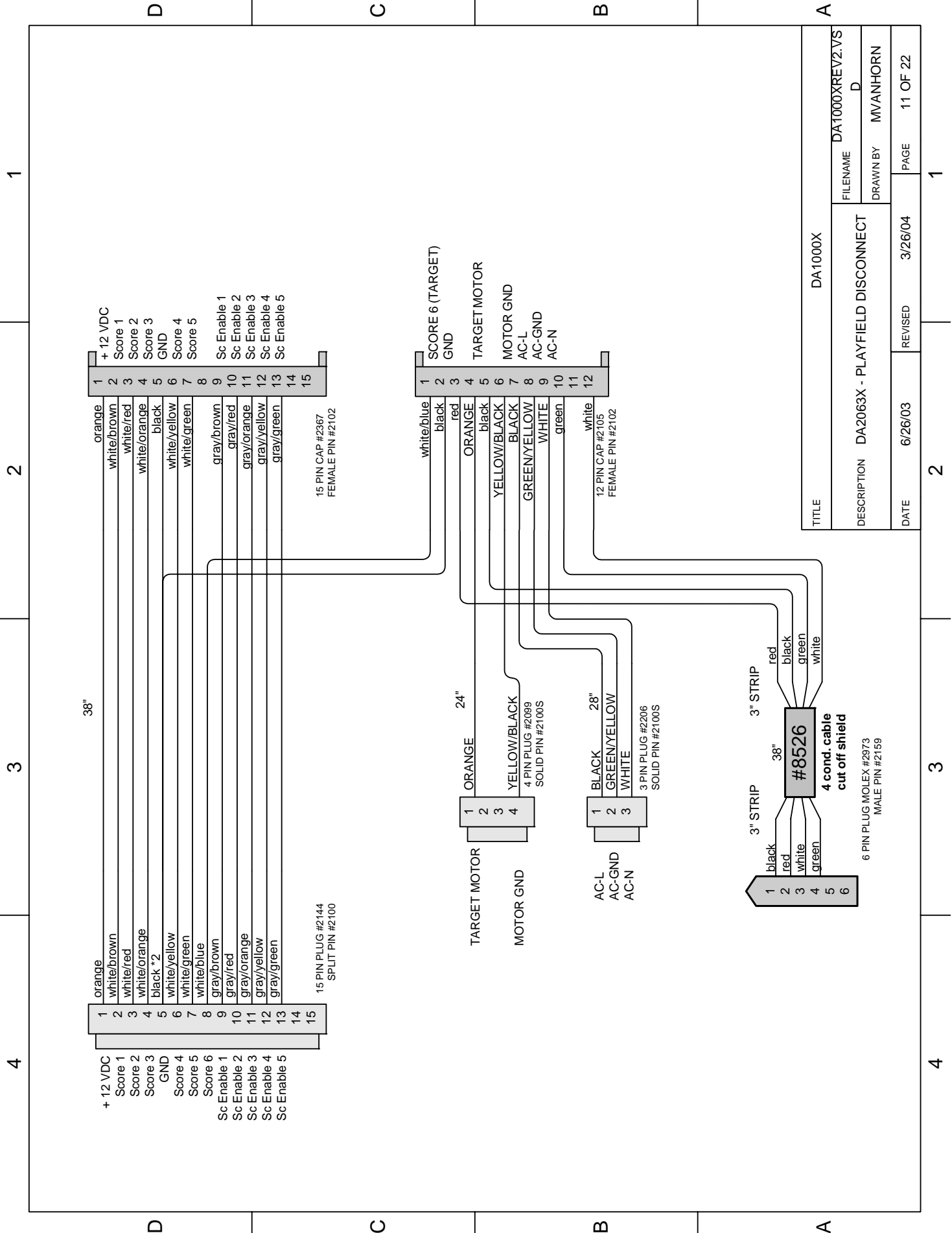

1	orange	+12 VDC
2	white/brown	Score 1
3	white/red	Score 2
4	white/orange	Score 3
5	black *2	GND
6	white/yellow	Score 4
7	white/green	Score 5
8	white/blue	Score 6
9	gray/brown	Sc Enable 1
10	gray/red	Sc Enable 2
11	gray/orange	Sc Enable 3
12	gray/yellow	Sc Enable 4
13	gray/green	Sc Enable 5
14		
15		

1	orange	SCORE 6 (TARGET)
2	white/blue	GND
3	black	TARGET MOTOR
4	red	MOTOR GND
5	ORANGE	AC-L
6	black	AC-GND
7	YELLOW/BLACK	AC-N
8	BLACK	
9	YELLOW/BLACK	
10	BLACK	
11	GREEN/YELLOW	
12	WHITE	
13	green	
14	white	
15		

1	black	SCORE 6 (TARGET)
2	red	GND
3	white	TARGET MOTOR
4	green	MOTOR GND
5	black	AC-L
6	red	AC-GND
7	white	AC-N
8	green	
9	black	
10	red	
11	white	
12	green	
13	black	
14	red	
15	white	

1	black	SCORE 6 (TARGET)
2	red	GND
3	white	TARGET MOTOR
4	green	MOTOR GND
5	black	AC-L
6	red	AC-GND
7	white	AC-N
8	green	
9	black	
10	red	
11	white	
12	green	
13	black	
14	red	
15	white	

TITLE	DA1000X	
DESCRIPTION	DA2063X - PLAYFIELD DISCONNECT	FILENAME DA1000XREV2.VS
DATE	6/26/03	DRAWN BY M/VANHORN
REVISED	3/26/04	PAGE 11 OF 22

4 3 2 1

D C B A

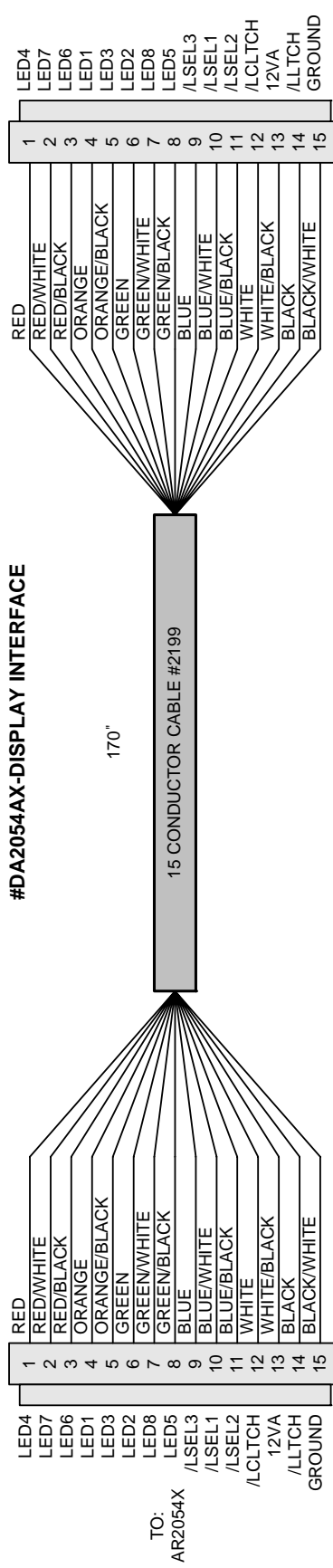

TITLE	DA1000X	
DESCRIPTION	DA2054AX - DISPLAY INTERFACE	FILENAME DA1000XREV2.VS
DATE	6/26/03	DRAWN BY MV/ANHORN
	REVISED	PAGE
	3/26/04	12 OF 22

4 3 2 1

1 2 3 4

D C B A

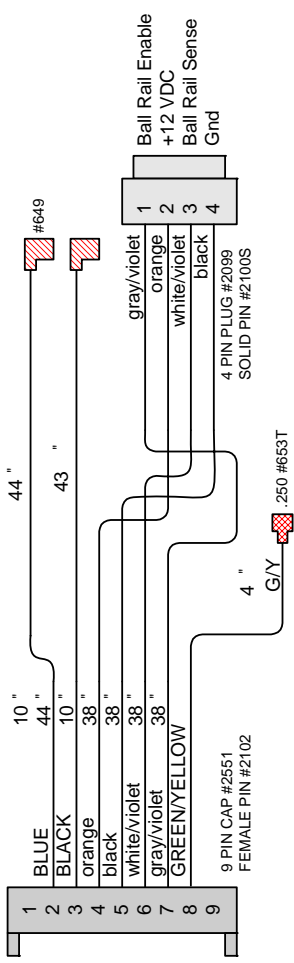

TITLE	DA1000X		FILENAME	DA1000XREV2.VS
DESCRIPTION	#DA2073X - Ball Release Harness		DRAWN BY	MVANHORN
DATE	6/26/03	REVISED	3/26/04	PAGE 13 OF 22

1 2 3 4



1 2 3 4

D D

C C

B B

A A

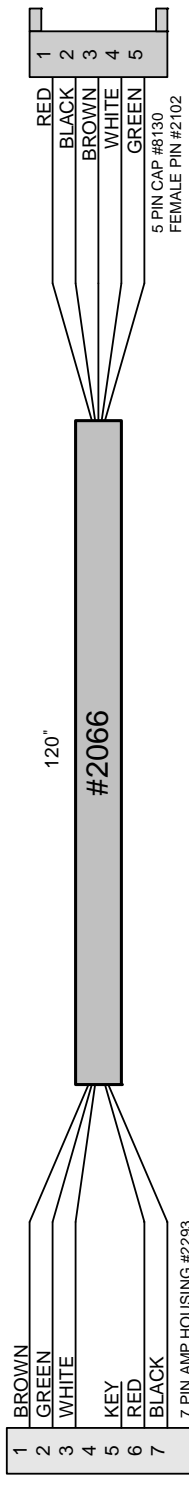

TITLE	DA1000X		
DESCRIPTION	FILENAME	DA1000XREV2.VS	
	DRAWN BY	MVANHORN	
DATE	6/26/03	REVISED	3/26/04
		PAGE	15 OF 22

1 2 3 4

1 2 3 4

D C B A

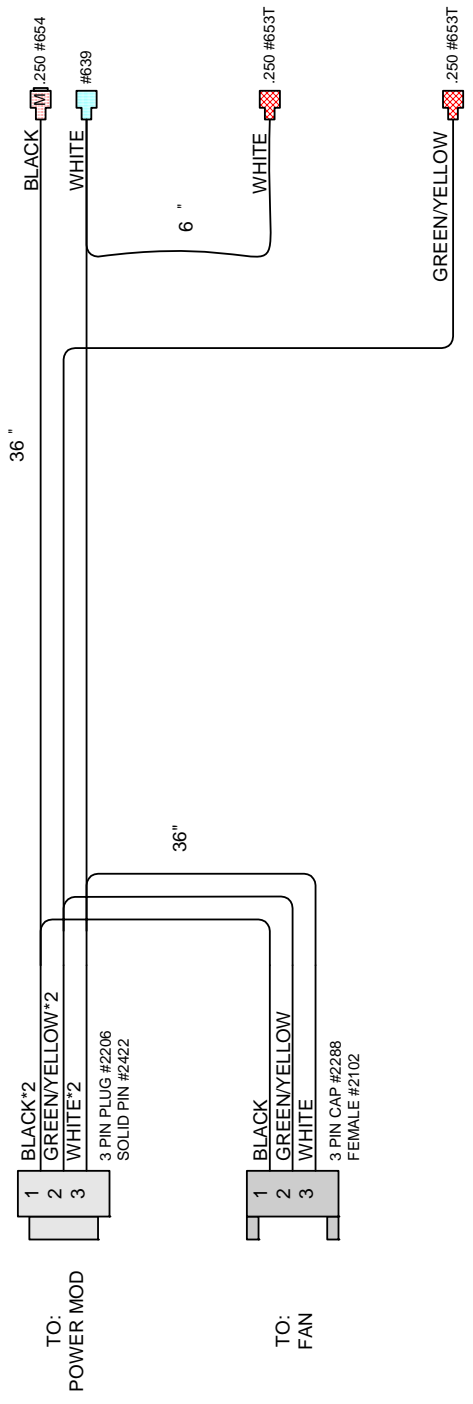

TITLE	DA1000X		FILENAME	DA1000XREV2.VS
DESCRIPTION	DA2069X		DRAWN BY	MVANHORN
DATE	6/26/03	REVISED	3/26/04	PAGE 17 OF 22

1 2 3 4

1 2 3 4

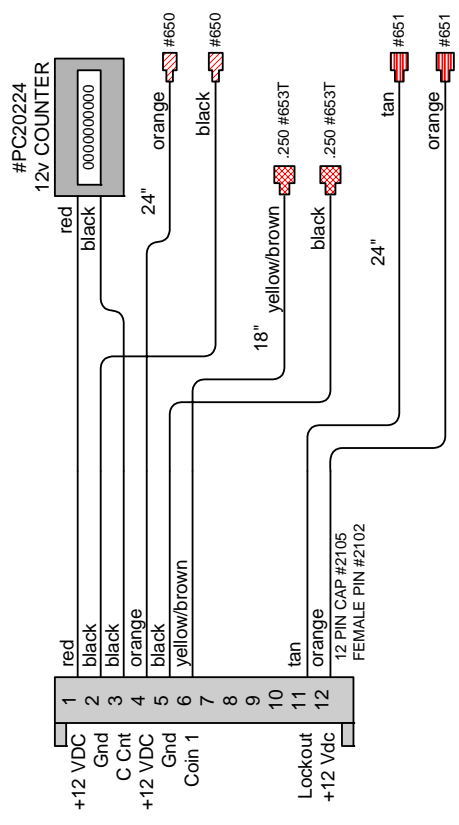

**DA2057X  
COIN DOOR**

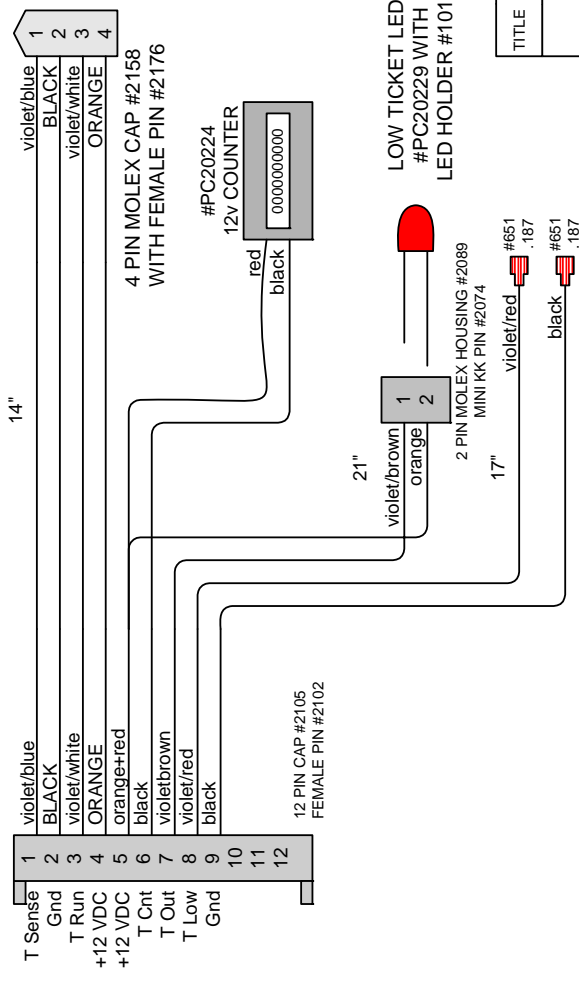

**DA2058X  
TICKET DOOR**

**LOW TICKET LED  
#PC20229 WITH  
LED HOLDER #1017**

TITLE	DA1000X	
DESCRIPTION	#DA2057X - Coin Door #DA2058X - Ticket Door	FILENAME DA1000XREV2.VS D
DATE	6/26/03	DRAWN BY MVANHORN
REVISED	3/26/04	PAGE 18 OF 22

1 2 3 4



1 2 3 4

D

C

B

A

#DA2070AX - SPEAKER CABLE EXTENSION

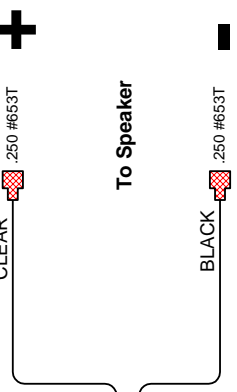
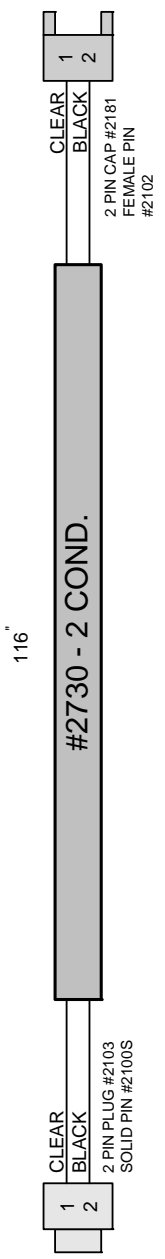

#DA2070X - SPEAKER CABLE

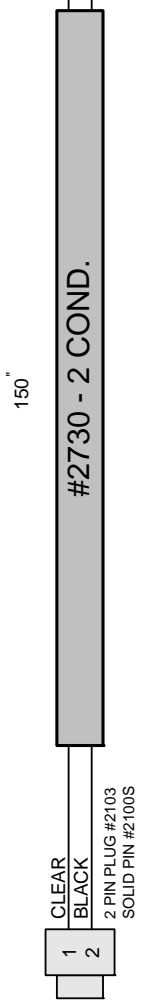

D

C

B

A

TITLE	DA1000X	
DESCRIPTION	#DA2070X - Speaker Cable #DA2070AX - Speaker Cable Extension	FILENAME DA1000XREV2.VS D
DATE	6/26/03	DRAWN BY MIVANHORN
	REVISED	PAGE 22 OF 22
	3/26/04	

1 2 3 4

# Warranty

I.C.E warrants all components in the **DUNK N' ALIEN™** game to be free of defects in materials and workmanship for a period of ninety days from the date of purchase.

This warranty does not cover items damaged due to normal wear and tear, subjected to abuse, improperly assembled by the end user, modified, repaired, or operated in a fashion other than that described in the service manual.

If your **DUNK N' ALIEN™** game fails to conform to the above-mentioned warranty, I.C.E.'s sole responsibility shall be at its option to repair or replace any defective component with a new or remanufactured component of equal to or greater O.E.M. specification.

I.C.E. will assume no liability whatsoever, for costs associated with labor to replace defective parts, or travel time associated therein.

I.C.E.'s obligation will be to ship free of charge, replacement parts by domestic U.P.S. Ground, U.S. mail, or other comparable shipping means. Any express mail or overnight shipping expense is at the cost of the purchaser.

Products will be covered under warranty only when:

- The serial number of the game with the defective parts is given.
- The serial number of the defective part, if applicable, is given.
- Defective parts are returned to I.C.E., shipping pre-paid, in a timely fashion, if requested by I.C.E.
- A copy of the sales receipt is available as proof of purchase upon request of I.C.E.

I.C.E. distributors are independent, privately owned and operated. In their judgment, they may sell parts or accessories other than those manufactured by I.C.E. We cannot be responsible for the quality, suitability, or safety of any non-I.C.E. part, or any modification, including labor, which is performed by such a distributor.



# WARRANTY

ICE Inc warrants that all of its products will be free from defects in material and workmanship.

When placing a warranty request, please be prepared to provide the following information:

- Serial Number of Game or Bill of Sale
- Machine Type
- A Detailed Description of the Equipment Fault Symptoms

ICE product, including Cromptons, Sam's Billiards, Uniana and Bell Fruit is warranted as follows:

- 180 days on the Main PCB and Computers
- 180 days on Motors
- 90 days on all other components (i.e. DBV's, Ticket Dispensers, etc)
- 30 days on repaired items
- 3 years on all Crane Harnessing
- 9 Months on Printers

ICE Inc shall not be obligated to furnish a warranty request under the following conditions:

- Equipment has been subjected to unwarranted stress through abuse or neglect
- Equipment has been damaged as a result of arbitrary repair/modification attempts
- Equipment that has failed through normal wear and tear

ICE Inc will assume no liability whatsoever for costs associated with labor to replace defective parts or travel time associated therein.

All defective warranty covered components will be replaced with new or factory refurbished components equal to OEM specifications. ICE Inc will cover all domestic UPS ground, or comparable shipping means, freight costs during the warranty period. Expedited shipments are available for an additional charge.

Defective parts are returned to ICE Inc, at the customer's expense, in a timely fashion.

ICE distributors are independent, privately owned and operated. In their judgment, they may sell parts and/or accessories other than those manufactured by ICE Inc. We cannot be responsible for the quality, suitability or safety of any non-ICE part, modification (including labor) that is performed by such a distributor.

I.C.E. Parts/Service Dept.  
Innovative Concepts in Entertainment  
10123 Main St.  
Clarence, NY 14031  
Phone #: (716) - 759 - 0360  
Fax #: (716) - 759 - 0884